

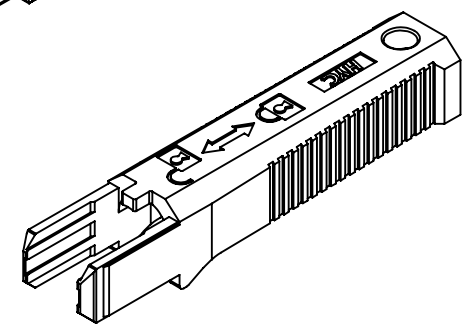

Version	Date	Amending content	Editor
A/0	2019.08.09	New issue	YHB

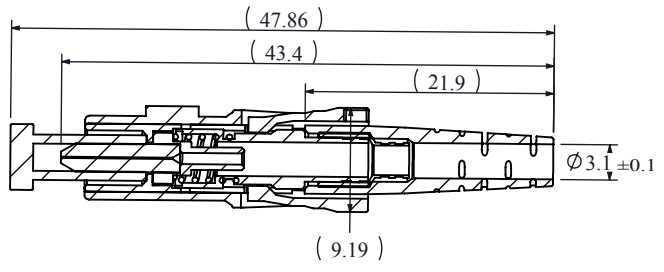

SECTION A-A

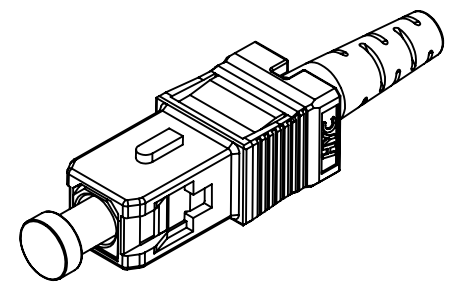
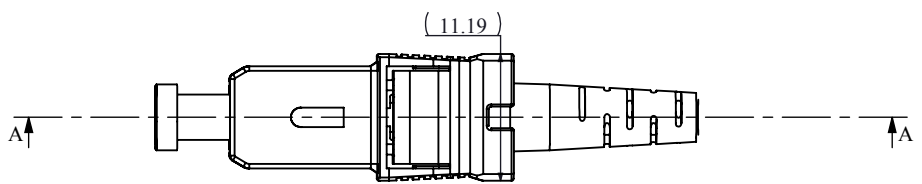
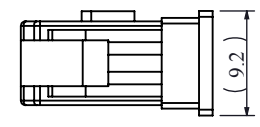
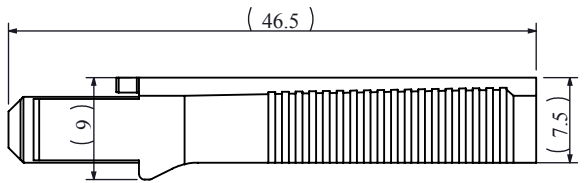
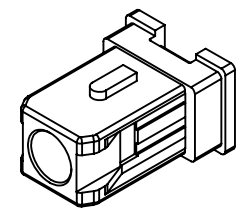
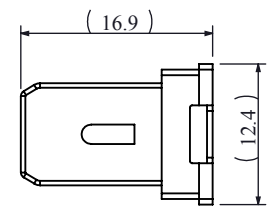
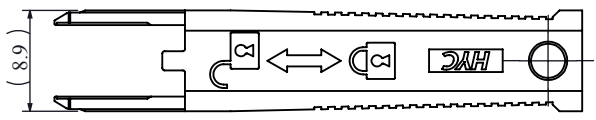

Comment:
 1.Rohs Compliant;
 2.Unspecified Tolerance: ± 0.1

Part Name	SC Secure Lockable Connector			 HYC Page :1-1
Material	/	Drawing No	H2-A-0302SC-001	
Drawing	Y H B	Date	2019.08.09	
Check	Z S F	Version	A/0	
Approval	W X B	Unit :mm	